



Handicraft

In this session, we are creating adorable insect origami of a mantis, spider, scorpion, bee, dragonfly, cicada, snail, butterfly, and ladybug! Images and step-by-step instructions have been provided for an easy process. Use different colors to match the insects, or choose decorative paper for interesting designs! This handicraft is the perfect hands-on activity for students young and old!

"I've filled him with the Spirit of God, giving him skill and know-how and expertise in every kind of craft to create designs ... he's an all-around craftsman."

~ Exodus 31:3-5

Handicraft Lesson

Let's Make a Mantis!

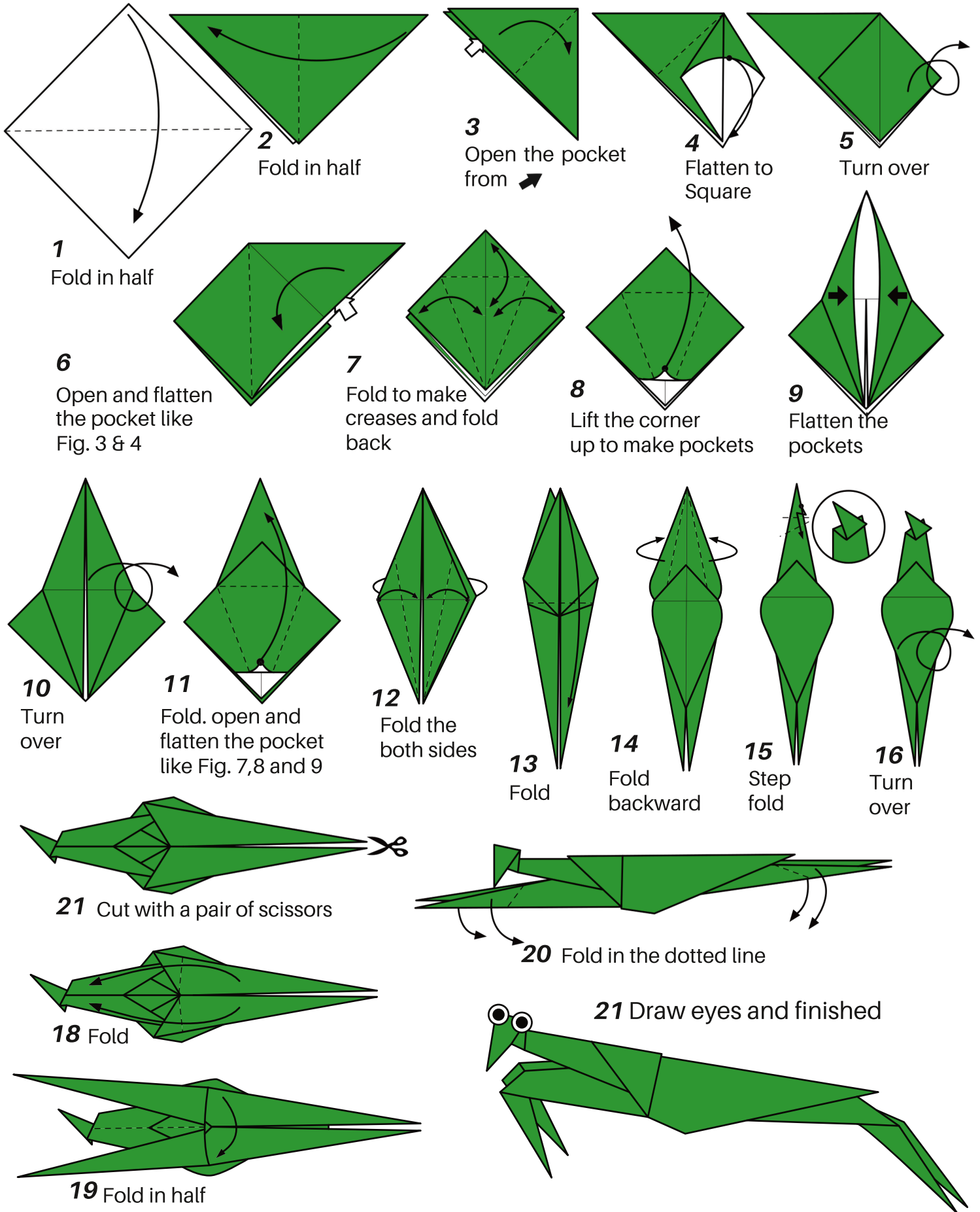

Let's Make a Spider!

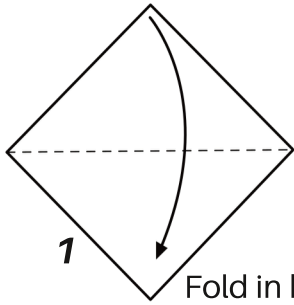

1 Fold in half

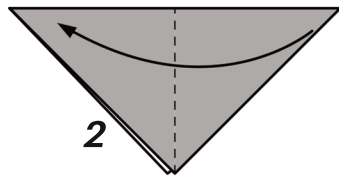

2 Fold in half

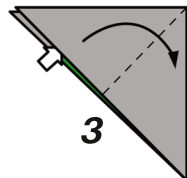

Open the part and flatten

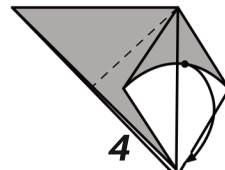

Flatten to triangle

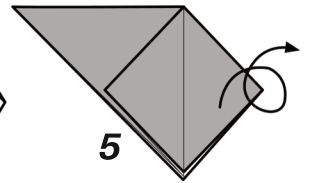

5 Turn over

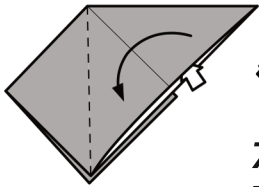

6 Open the part and flatten

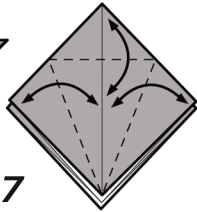

7 Fold to make a crease and fold back

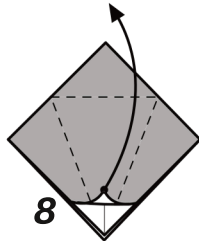

8 Flatten to square

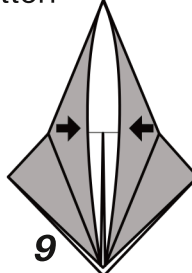

9 Flatten to square

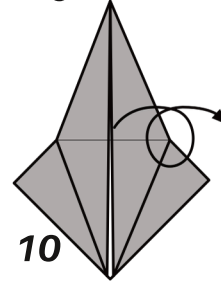

10 Turn over

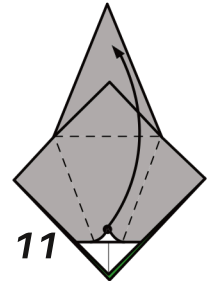

11 Flatten to square

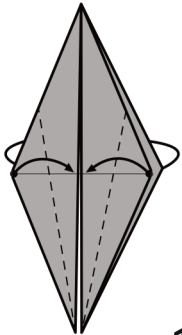

12 Fold to make a crease and fold back

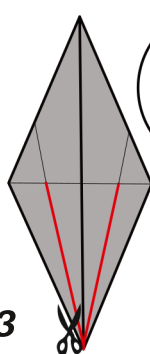

13 Cut it with scissors

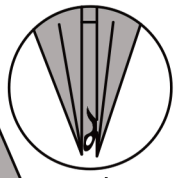

Cut the paper inside, too

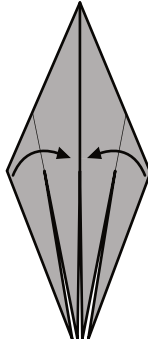

14 Fold to meet the center line. Back is the same, too

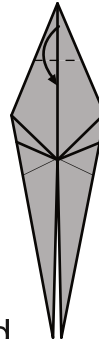

15 Fold backward

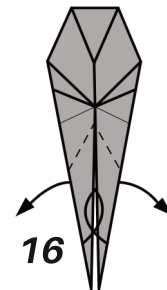

16 Fold in the dotted the dotted line. Back is the same, too

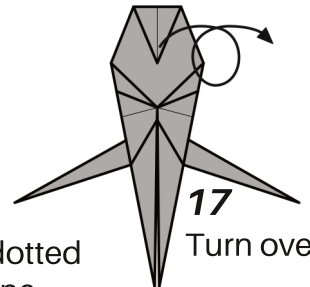

17 Turn over

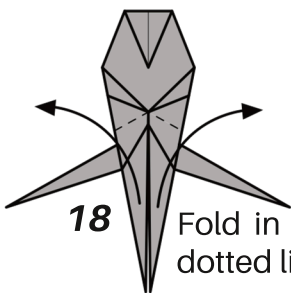

18 Fold in the dotted line

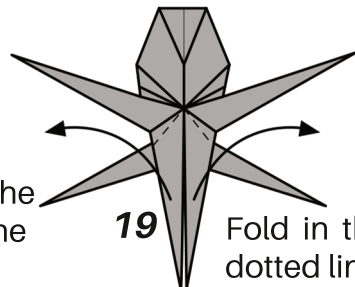

19 Fold in the dotted line

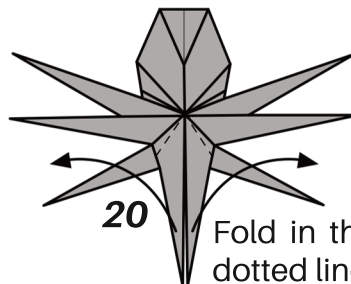

20 Fold in the dotted line

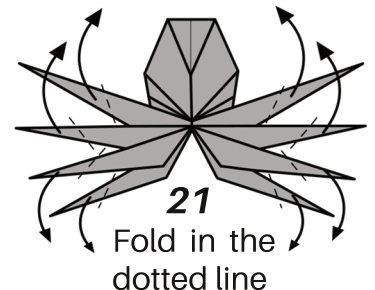

21 Fold in the dotted line

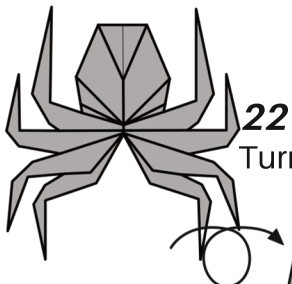

22 Turn over

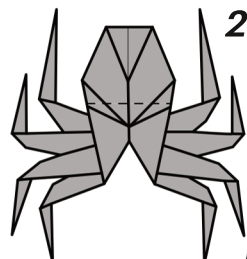

23 Fold in the dotted line

24 Fold and insert it

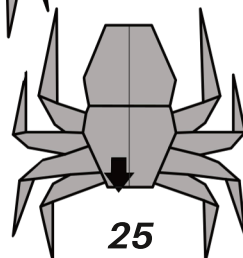
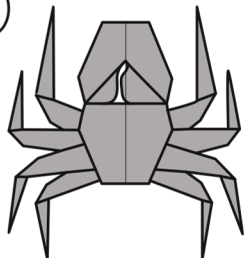

25 Pull the paper

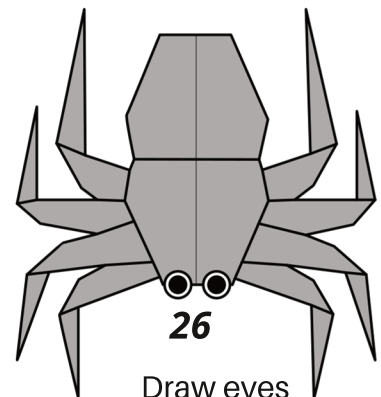

26 Draw eyes and finished

Let's Make a Scorpion!

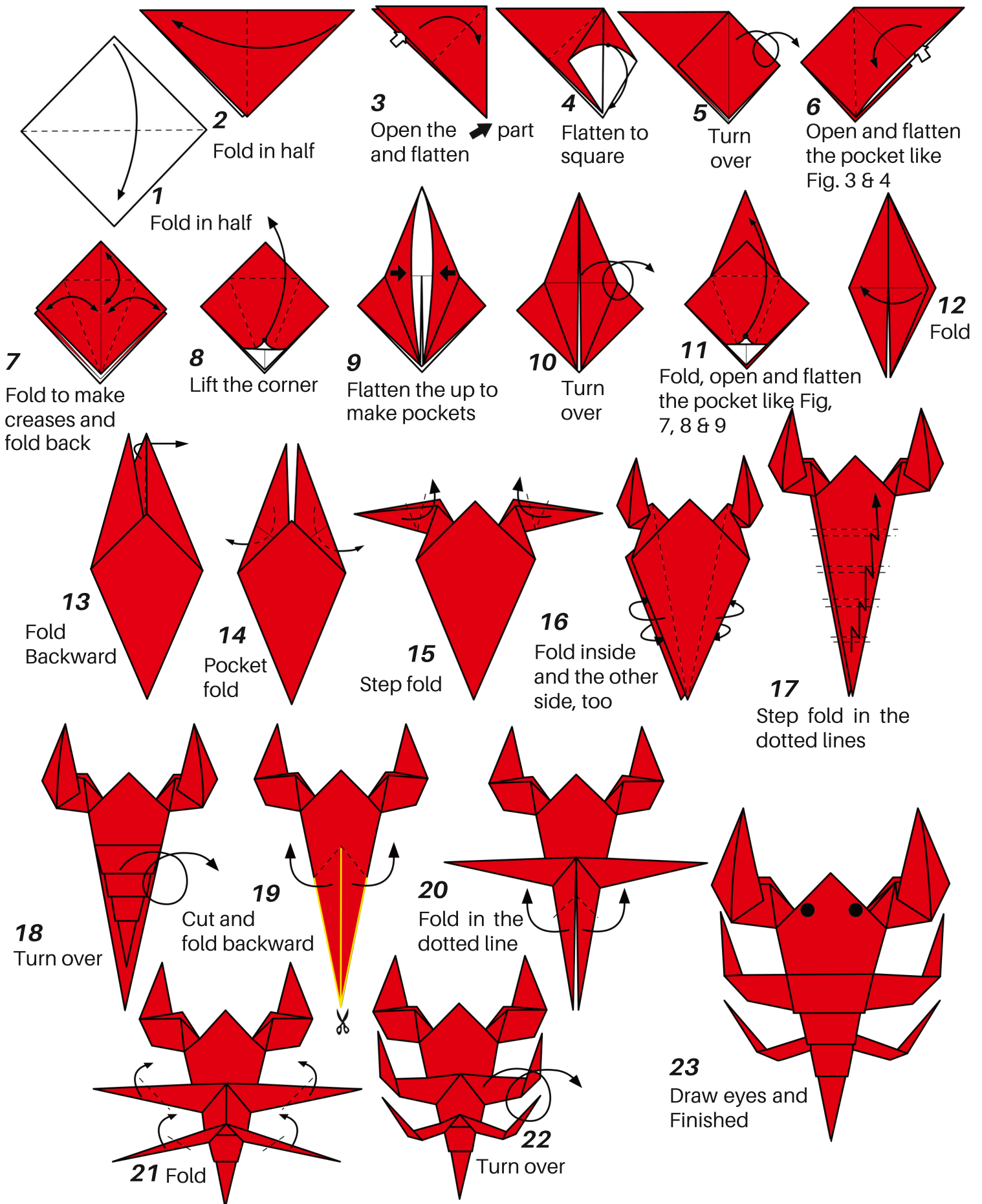

Let's Make a Bee!!

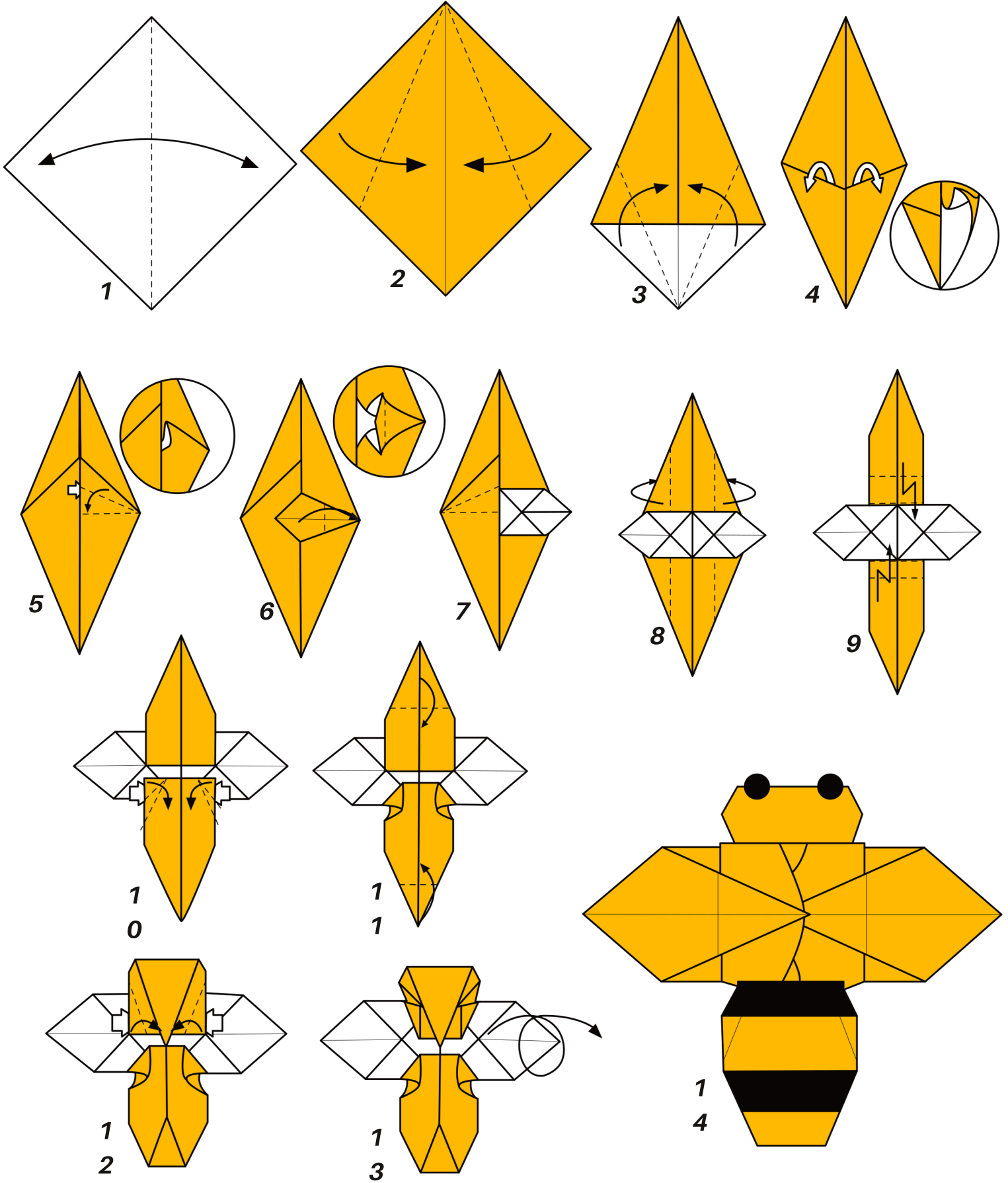

Let's Make a Dragonfly!

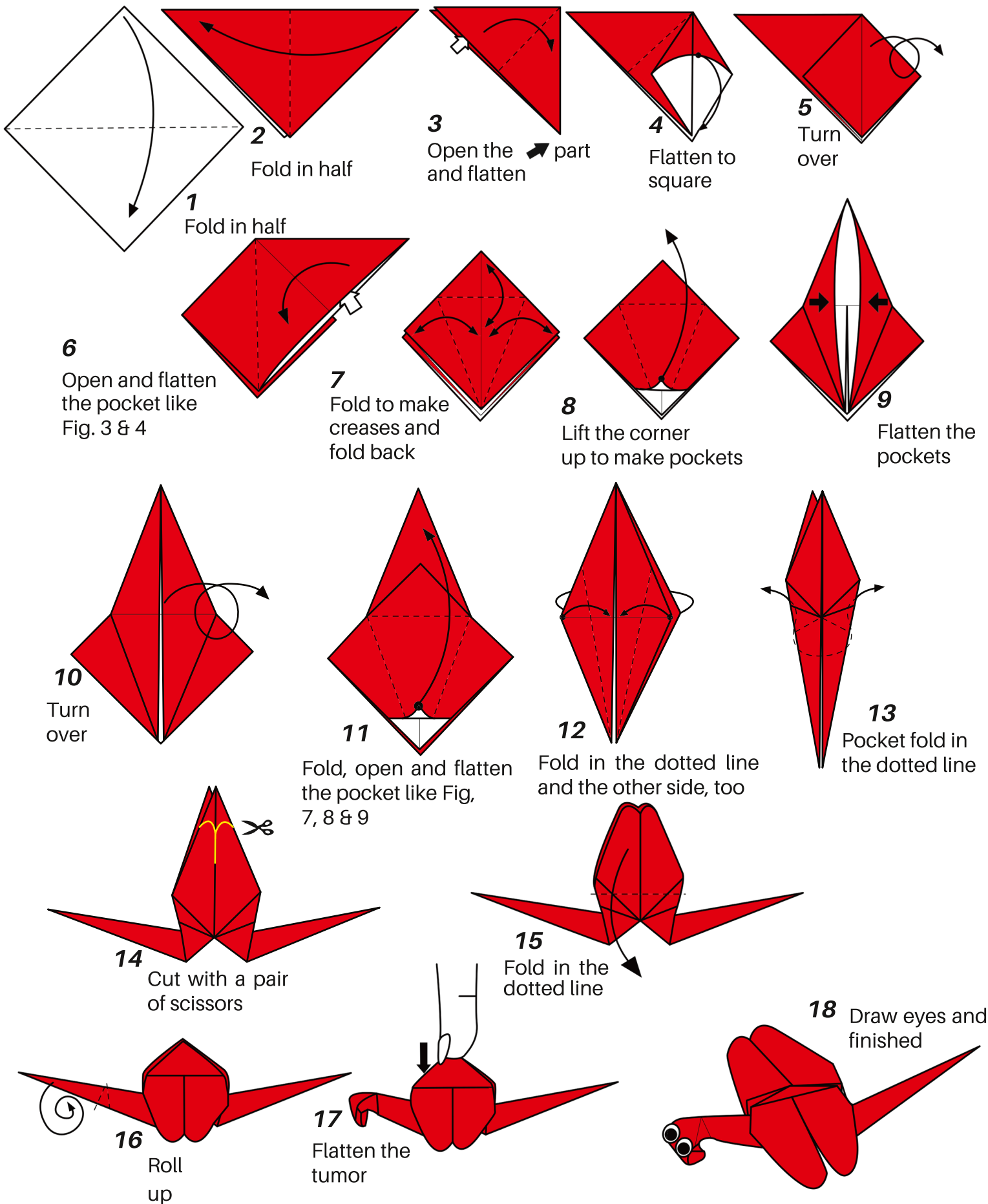

Let's Make a Cicada!

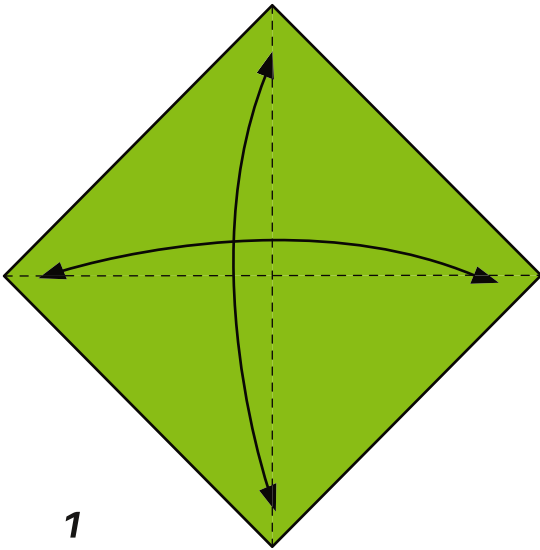

1
Fold in the dotted lines to make creases and fold back

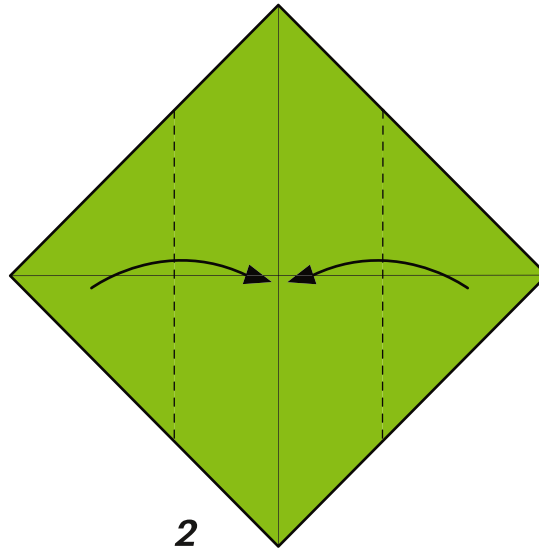

2
Fold to meet the center line

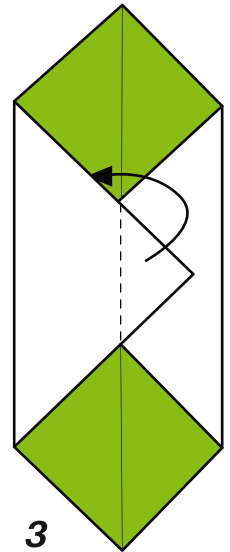

3
Fold backward

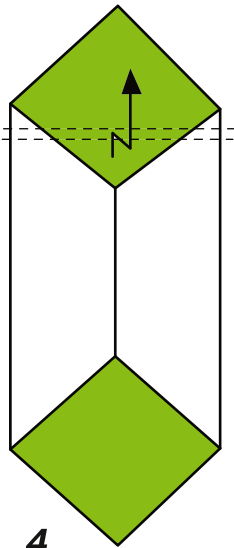

4
Step fold

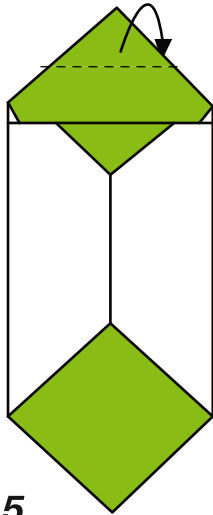

5
Fold backward

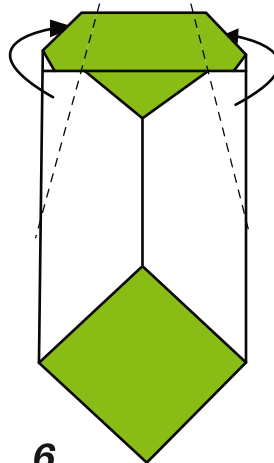

6
Fold backward

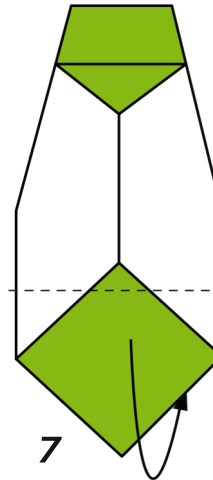

7
Fold backward

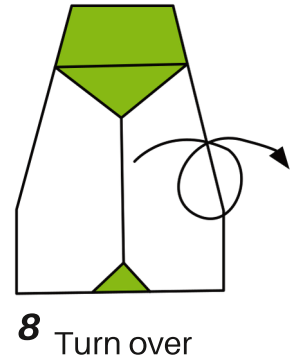

8
Turn over

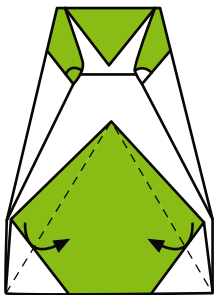

9
Fold in the dotted line

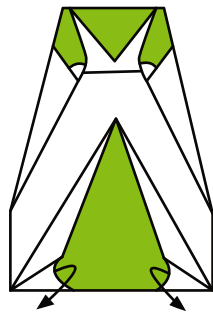

10
Pull inside out

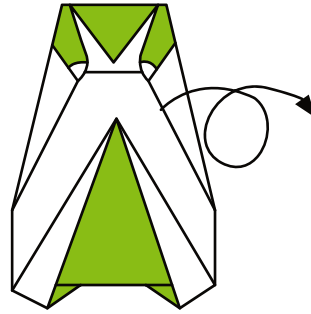

11
Turn over

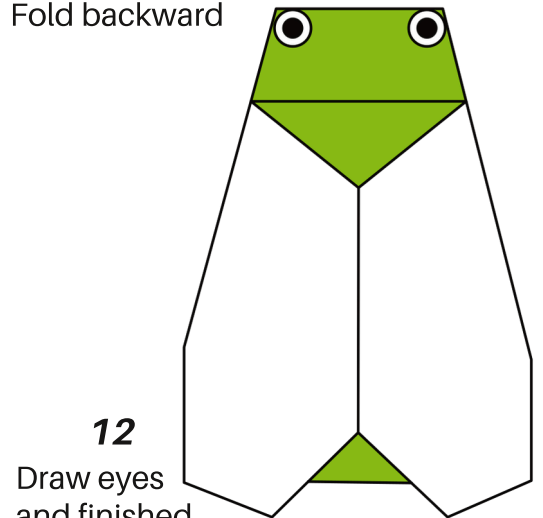

12
Draw eyes and finished

Let's Make a Snail!

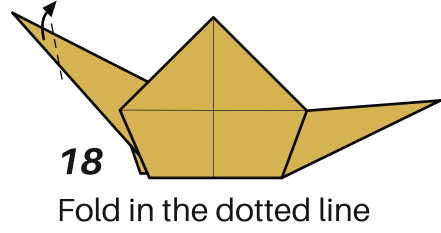
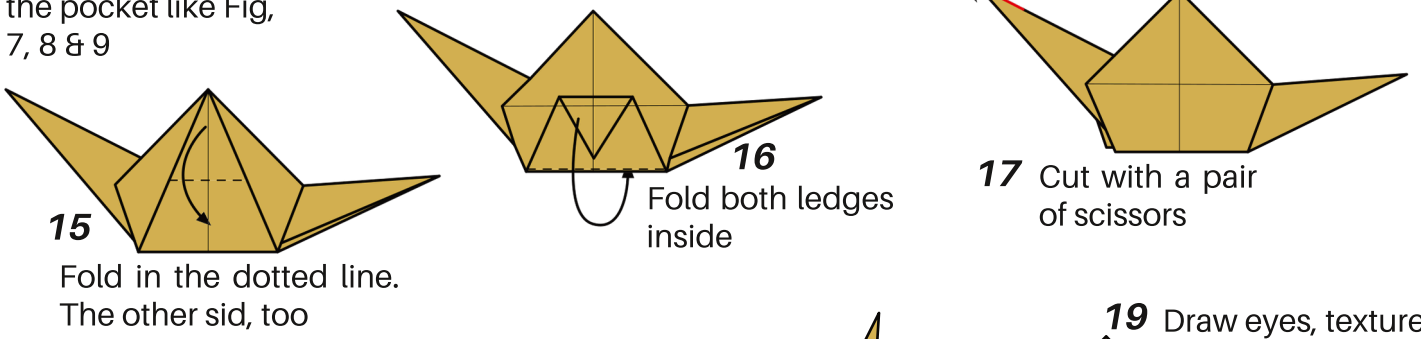
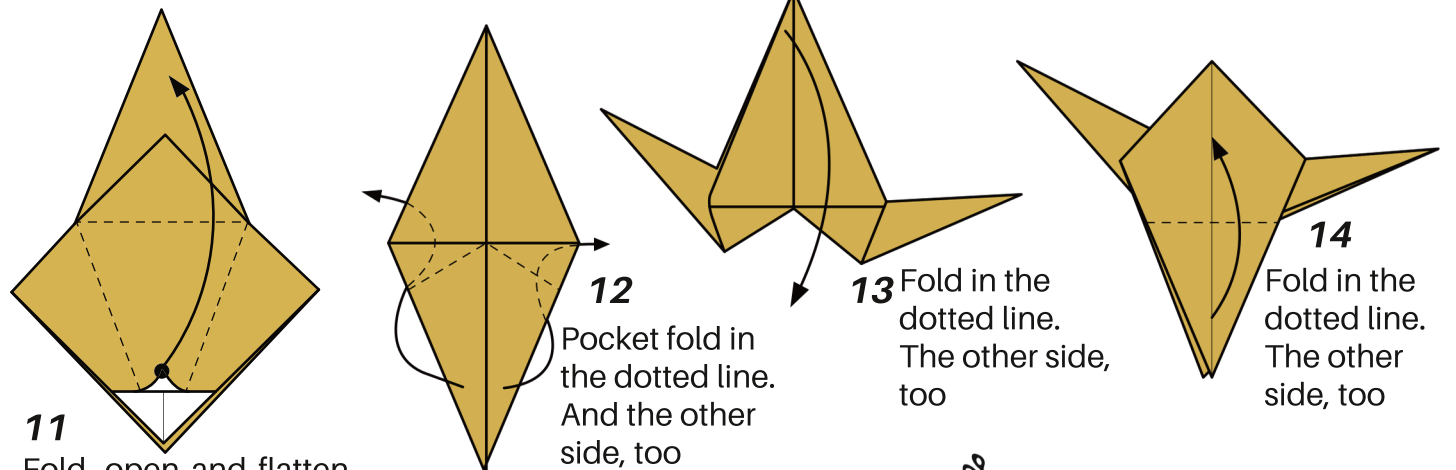
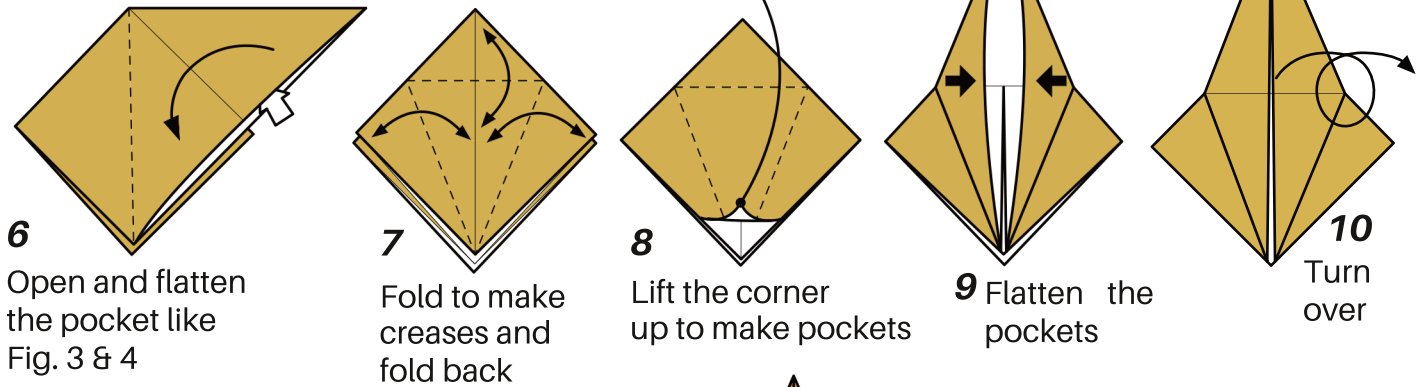
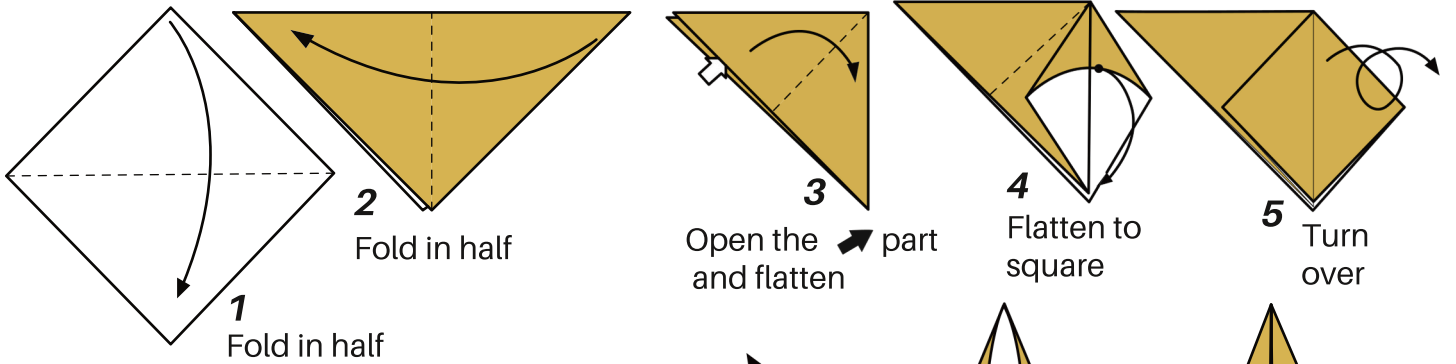

Let's Make a Butterfly!

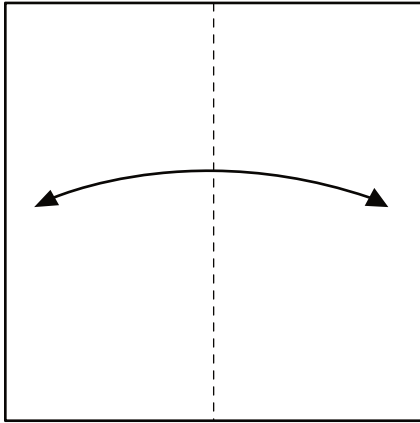

1 Fold in half to make creases and fold back

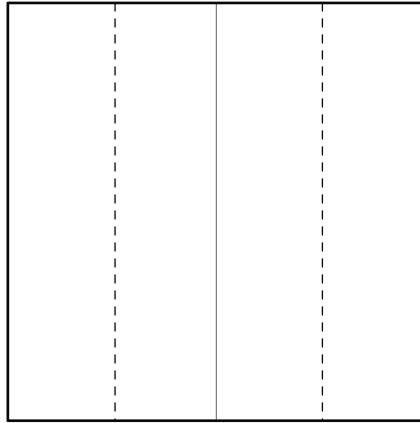

2 Fold in the dotted line to meet the center line

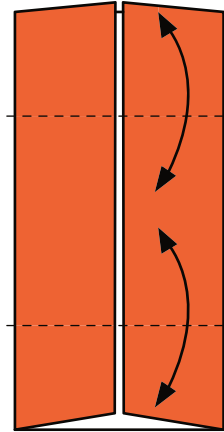

3 Fold to make crease and fold back

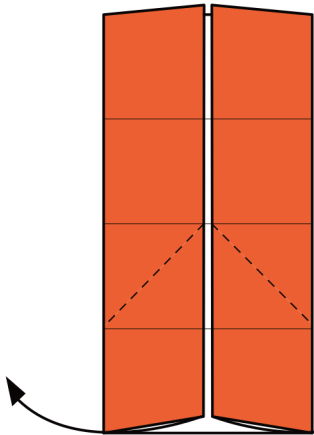

4 Open the corners and fold forward

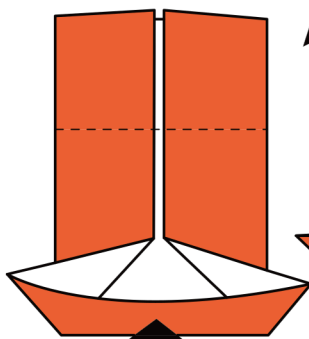

5 Flatten

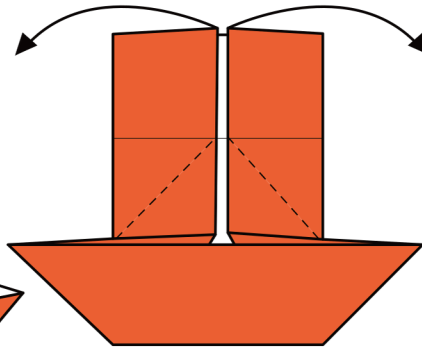

6 Open and flatten like Fig. 4 & 5

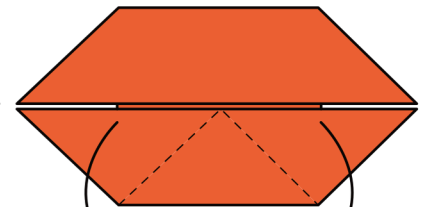

7 Fold in the dotted lines

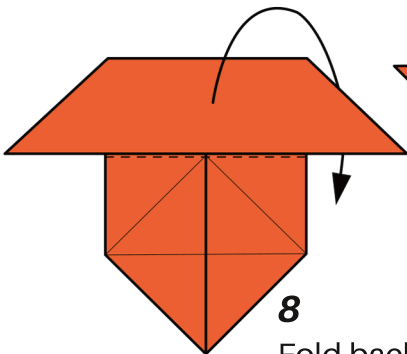

8 Fold backward in the dotted lines

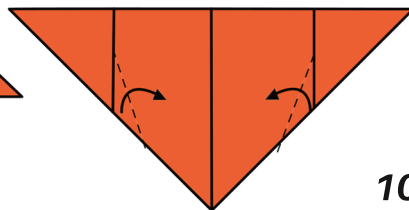

9 Fold in the dotted lines

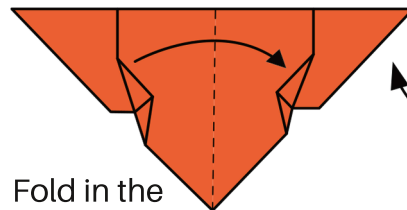

10 Fold in the dotted lines

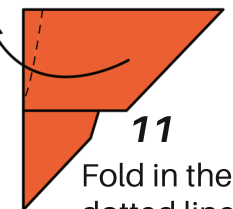

11 Fold in the dotted lines

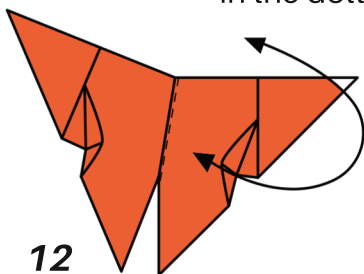

12 Fold to make crease and fold back

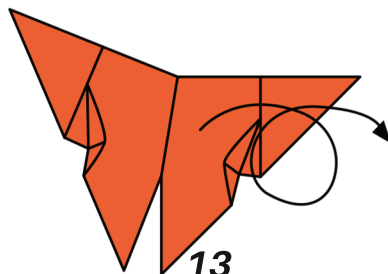

13 Turn over

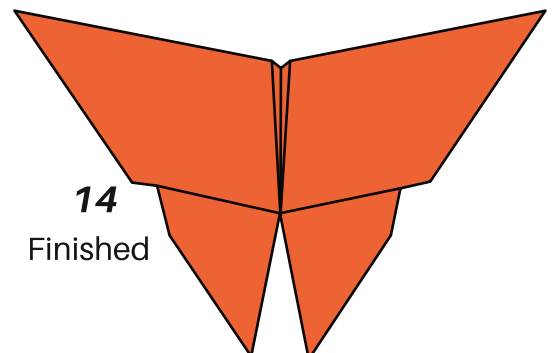

14 Finished

Let's Make a Ladybug!

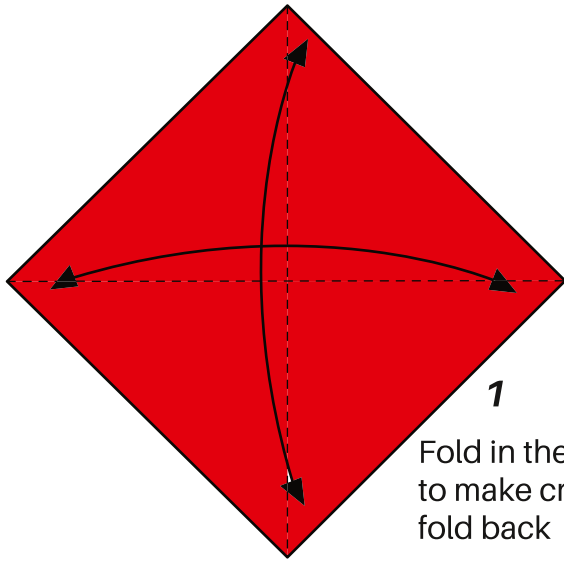

Fold in the dotted lines to make creases and fold back

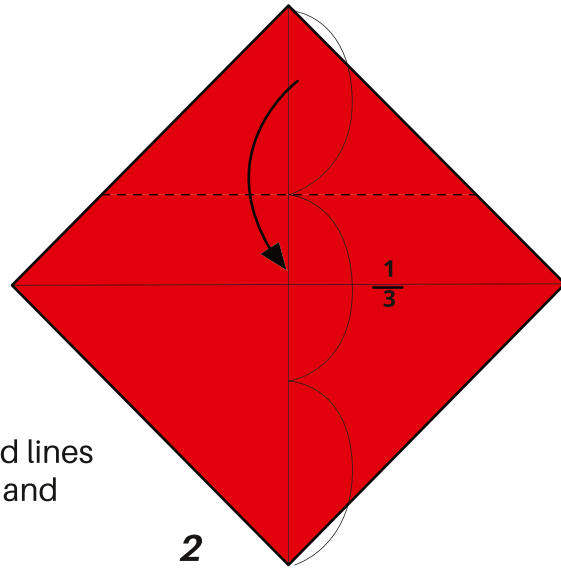

Fold in the dotted lines

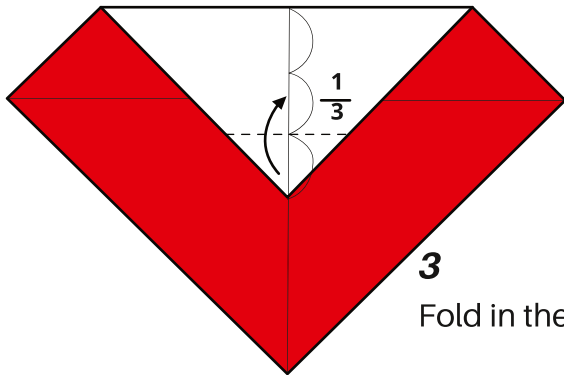

Fold in the dotted lines

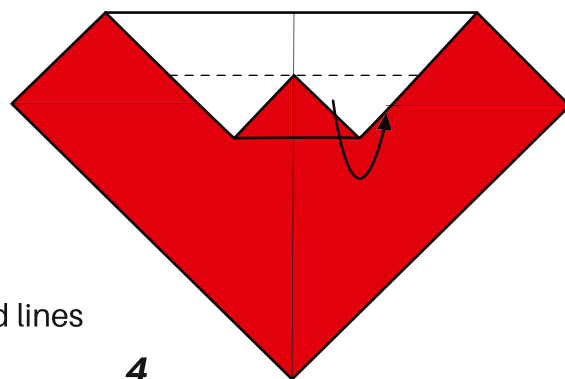

Fold inside in the dotted lines

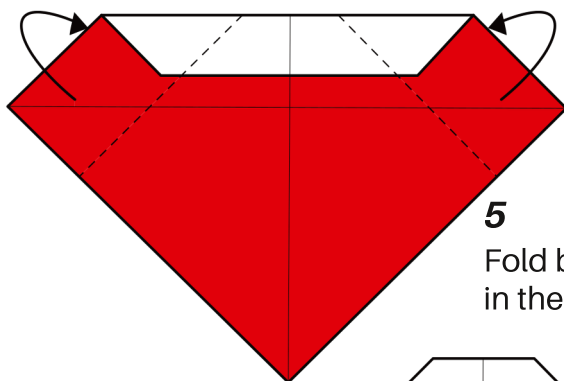

Fold backward in the dotted lines

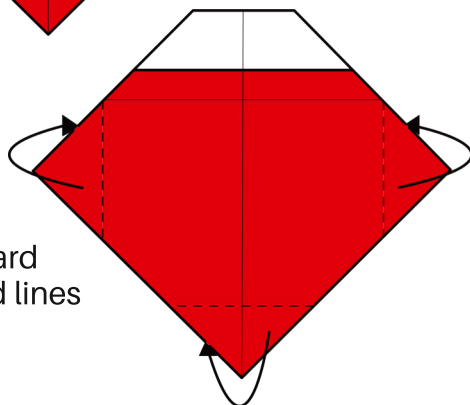

Fold backward in the dotted lines

7 Draw eyes and spots and finished

